

IB 3600

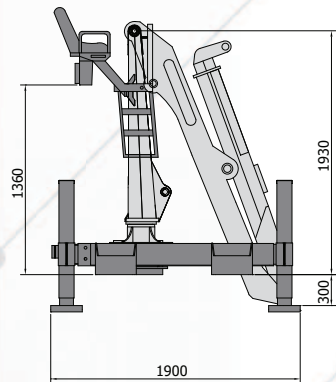
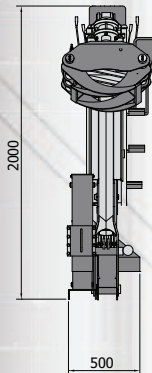
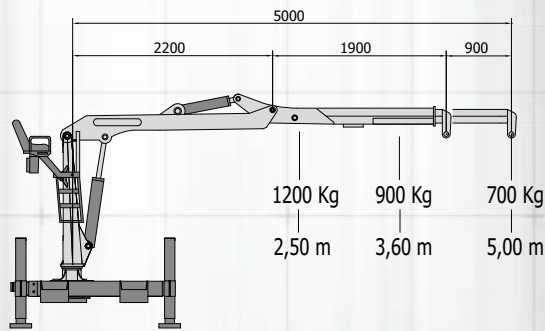
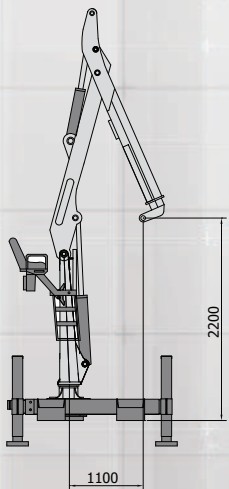

TECHNISCHE DATEN / DONNÉES TECHNIQUES

IB3600

Maximales moment / Capacité de levage maximale	36 KNm
Drehmoment (netto) / Couple de rotation nette	15 KNm
Drehwinkel / Angle de rotation	400°
Maximale reichweite / Maximale extension du bras	5,00 m
Betriebs-/arbeitsdruck / Pression de service \ travail	190 Bar
Empfohlene durchflussmenge der pumpe / Débit recommandé pour la pompe	35 lt/ 45 min
Lader-/krangewicht (ausschliesslich endausrüstungen) Poids du chargeur \ grue (exclus équipements d'extrémité).	850 Kg

